

VC

VENTILATORE AD ALTO RENDIMENTO
HIGH EFFICIENCY FAN

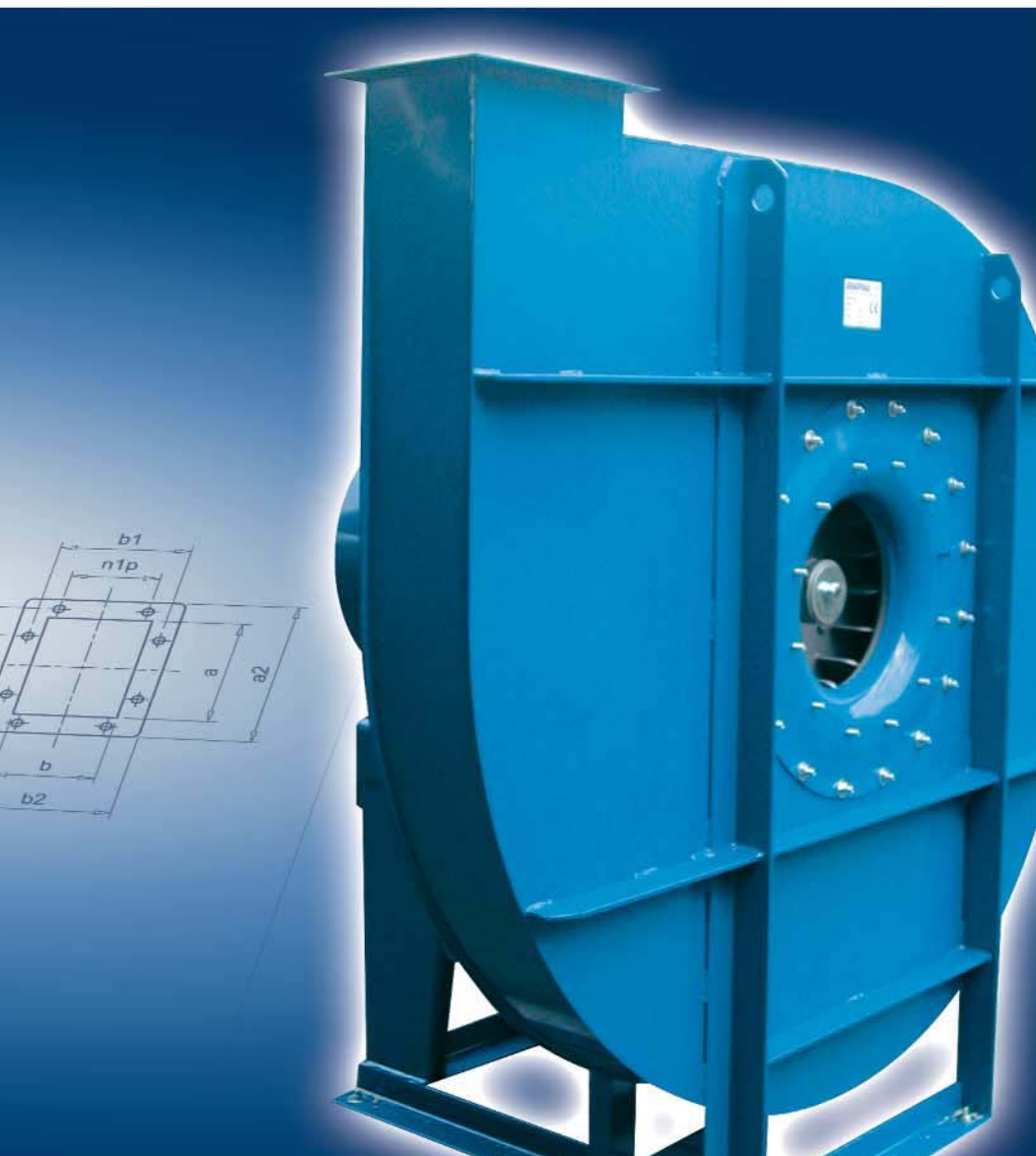

GIRANTE A PALE CURVE ROVESCE
BACKWARD CURVED BLADES IMPELLER



ALTISSIMA PRESSIONE
VERY HIGH PRESSURE

Portata/Flow rate:
250 ÷ 6200 m³/h

Pressione/Pressure:
420 ÷ 2500 mm H₂O





VC

VENTILATORE AD ALTO RENDIMENTO HIGH EFFICIENCY FAN



Ventilatore ad alto rendimento: Mod. VC.

Campo di lavoro: portate piccole e medie, prevalenze alte.

Tipo di pale: rovesce, negative. Applicazioni: per trasporto pneumatico, polveri, essiccazione, pressurizzazione.

Temperatura del fluido: fino a 60° C in esecuzione standard; esecuzioni speciali per temperature superiori. Caratteristiche costruttive: ventilatore di costruzione particolarmente robusta eseguito in lamiera verniciata, ventola in acciaio equilibrata staticamente e dinamicamente.

Caratteristiche di funzionamento:

condizioni dell'aria in aspirazione $T = 15^{\circ} \text{C}$, $p = 760 \text{ mm Hg}$

Costruzioni speciali.

Versione anticorrosiva: esecuzione con verniciature o materiali speciali (acciaio inox). Versione per alte temperature: con ventolina di raffreddamento fino a 300°C, esecuzioni speciali a richiesta per temperature fino a 450°C. Esecuzione ATEX (94/9/CE) disponibile.

High efficiency fan: Mod. VC.

Field of application: medium and low capacities, high pressures.

Type of blades: backward, negative. Applications: for the pneumatic conveyance dirty air, drying system. Particularly suitable for foundries and chemical industry. Air temperature: up to 60° C standard, special features for higher temperatures.

Construction specifications: rigid construction in sheet metal.

Statically and dynamically balanced impellers.

Working principles: condition of ducted air $T = 15^{\circ} \text{C}$, $p = 760 \text{ mm Hg}$.

Noise level: noise level are obtained by readings taken at 4 points, at a distance of 1,5mt from the fan.

Motors and trasmission are excluded. Readings are in free field with a ducted fan according to EN10531.

Special constructions.

Corrosion resistant version with special coatings or material (stainless steel). Temperature resistant feautres with small cooling disc up to 300°C. Special arrangement on request up to 450°C.

ATEX exection (94/9/CE) available.



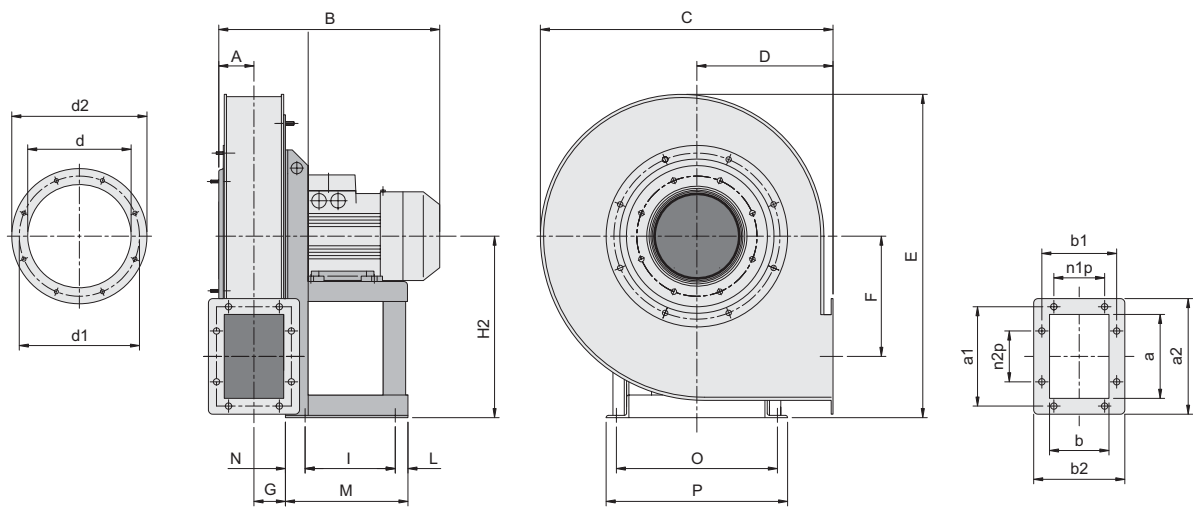

Orientamento RD 270
Position RD 270

Direzioni di rotazione (vista lato motore) - Rotation senses (seen from motor side)

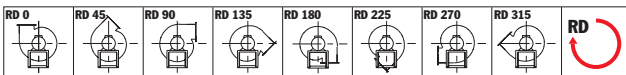

Rotazione oraria - Clockwise rotation sense

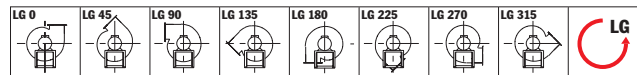

Rotazione anti-oraria - Anti-Clockwise rotation sense

DIMENSIONI D'INGOMBRO

OVERALL DIMENSIONS



VC 500÷1120

TIPO - TYPE		PESO WEIGHT	PD² GD²	VENTILATORE FAN									
VENTILATORE FAN	MOTORE MOTOR			kgf	kgf m²	A	B	C	D	E	F	G	H
VC 500/N2	80 B2	63	1,2	48	340	715	335	795	347	41	450	450	450
VC 560/N2	90 S2	95	1,8	52	385	805	375	890	393	46	500	500	500
VC 560/N2	90 L2	98	1,8										
VC 630/N2RI	90 L2	125	2,4	58	395	910	425	1000	443	53	560	560	560
VC 630/N2RI	100 LA2	124	2,4										
VC 630/N2	100 LA2	130	3,1										
VC 630/N2	112 M2	134	3,1										
VC 710/N2RI	112 M2	162	4,3	64	545	1015	475	1122	497	58	630	630	630
VC 710/N2RI	132 SA2	175	4,3										
VC 710/N2	132 SA2	179	5,9										
VC 710/N2	132 SB2	185	5,9										
VC 800/N2RI	132 SB2	219	7,8	70	555	1140	530	1265	560	64	710	710	710
VC 800/N2RI	132 MB2	227	7,8										
VC 800/N2	132 MB2	232	10,2										
VC 800/N2	160 MA2	256	10,2										
VC 900/N2RI	160 MA2	357	13,8	77	705	1285	600	1428	631	71	800	800	800
VC 900/N2RI	160 MB2	363	13,8										
VC 900/N2	160 MB2	369	17,5										
VC 900/N2	160 L2	380	17,7										
VC 1000/N2RI	180 M2	447	23	86	725	1430	670	1590	707	81	900	900	900
VC 1000/N2	180 M2	467	24										
VC 1000/N2	200 LA2	522	24										
VC 1120/N2RI	225 M2	700	40	95	895	1600	750	1770	791	91	1000	1000	1000
VC 1120/N2	225 M2	730	43										
VC 1120/N2	250 M2	795	43										

Peso ventilatore in Kgf (completo di motore)
 Weight of ventilator (complete with motor)
NOTA: quota B indicativa
 NOTE: "B" quote indicative

TIPO - TYPE	FLANGIA ASPIRANTE INLET FLANGE					FLANGIA PREMENTE OUTLET FLANGE										BASAMENTO BASE																													
	d	d ₁	d ₂	n°	∅	a	b	a ₁	b ₁	a ₂	b ₂	n ₁ xp	n ₂ xp	n°	∅	I	J	K	L	M	N	O	P	Q	R	S	T	U	∅																
VC 500/N2	145	182	215	8	8	105	76	139	110	165	136	-	-	4	10	121	-	-	45	211	45	203	225	-	-	-	-	-	-	10															
VC 560/N2	165	200	235	8	8	117	85	151	119	177	145	-	-	4	10	133	-	-	58	246	55	234	260	-	-	-	-	-	-	10															
VC 630/N2RI	185	219	250	8	8	131	95	165	129	191	155	-	1x100	6	10	133	-	-	58	246	55	234	260	-	-	-	-	-	-	10															
VC 630/N2RI																197	-	-	58	246	30	289	324	-	-	-	-	-	-	-	-	-	-	-	-	-	-	-	-	-	-	-	-	12	
VC 630/N2																197	-	-	49	276	30	289	324	-	-	-	-	-	-	-	-	-	-	-	-	-	-	-	-	-	-	-	-	-	12
VC 630/N2																197	-	-	49	276	30	289	324	-	-	-	-	-	-	-	-	-	-	-	-	-	-	-	-	-	-	-	-	-	12
VC 710/N2RI	205	241	275	8	8	146	105	182	139	216	175	-	1x112	6	12	237	-	-	49	276	40	289	372	-	-	-	-	-	-	-	12														
VC 710/N2RI																237	-	-	49	336	40	337	372	-	-	-	-	-	-	-	-	-	-	-	-	-	-	-	-	-	-	-	-	12	
VC 710/N2																237	-	-	59	336	40	337	372	-	-	-	-	-	-	-	-	-	-	-	-	-	-	-	-	-	-	-	-	-	12
VC 710/N2																237	-	-	59	336	40	337	372	-	-	-	-	-	-	-	-	-	-	-	-	-	-	-	-	-	-	-	-	-	12
VC 800/N2RI	228	265	298	8	8	166	117	200	151	236	187	-	1x112	6	12	237	-	-	59	336	40	337	372	-	-	-	-	-	-	-	12														
VC 800/N2RI																237	-	-	59	336	40	337	372	-	-	-	-	-	-	-	-	-	-	-	-	-	-	-	-	-	-	-	-	12	
VC 800/N2																237	-	-	59	336	40	337	372	-	-	-	-	-	-	-	-	-	-	-	-	-	-	-	-	-	-	-	-	-	12
VC 800/N2																337	-	-	49	436	50	395	440	-	-	-	-	-	-	-	-	-	-	-	-	-	-	-	-	-	-	-	-	-	14
VC 900/N2RI	255	292	325	8	10	185	131	219	165	255	201	-	1x112	6	12	337	-	-	49	436	50	395	440	-	-	-	-	-	-	-	14														
VC 900/N2RI																337	-	-	49	436	50	395	440	-	-	-	-	-	-	-	-	-	-	-	-	-	-	-	-	-	-	-	-	14	
VC 900/N2																337	-	-	49	436	50	395	440	-	-	-	-	-	-	-	-	-	-	-	-	-	-	-	-	-	-	-	-	-	14
VC 900/N2																337	-	-	49	436	50	395	440	-	-	-	-	-	-	-	-	-	-	-	-	-	-	-	-	-	-	-	-	-	14
VC 1000/N2RI	285	332	365	8	10	207	148	241	182	277	218	1x112	1x112	8	12	357	-	-	33	460	70	434	488	-	-	-	-	-	-	17															
VC 1000/N2																357	-	-	33	460	70	434	488	-	-	-	-	-	-	-	-	-	-	-	-	-	-	-	-	-	-	-	17		
VC 1000/N2																381	-	-	39	500	80	506	568	-	-	-	-	-	-	-	-	-	-	-	-	-	-	-	-	-	-	-	-	19	
VC 1120/N2RI	320	366	400	8	10	231	166	265	200	301	236	1x112	1x112	8	12	421	-	-	39	540	80	556	616	-	-	-	-	-	-	19															
VC 1120/N2																421	-	-	39	540	80	556	616	-	-	-	-	-	-	-	-	-	-	-	-	-	-	-	-	-	-	-	19		
VC 1120/N2																501	-	-	39	600	60	604	690	-	-	-	-	-	-	-	-	-	-	-	-	-	-	-	-	-	-	-	-	19	

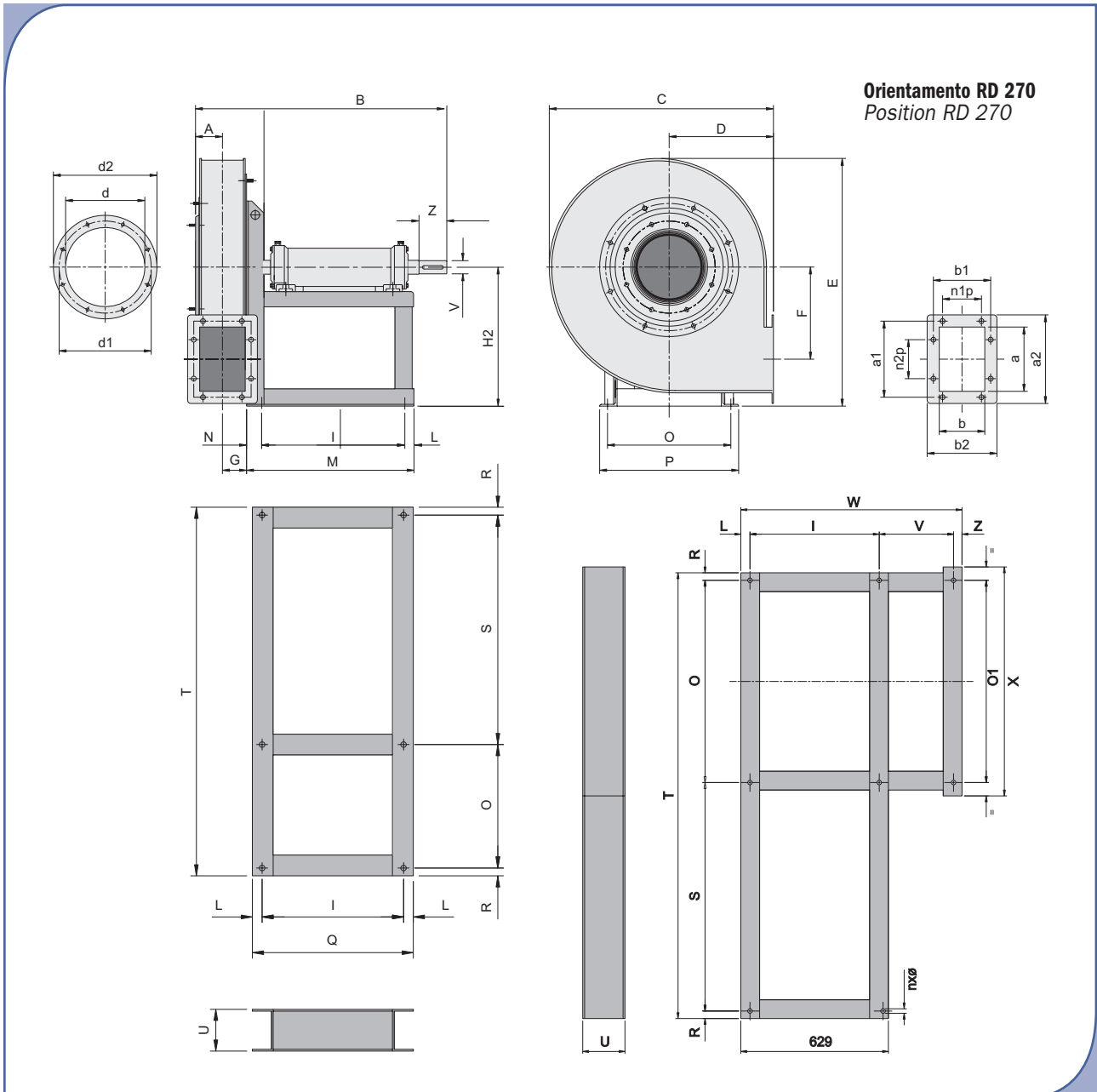

Direzioni di rotazione (vista lato motore) - Rotation senses (seen from motor side)

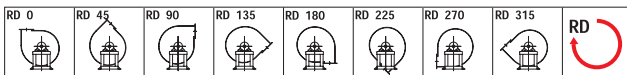

Rotazione oraria - Clockwise rotation sense

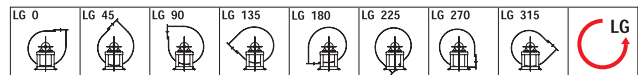

Rotazione anti-oraria - Anti-Clockwise rotation sense

DIMENSIONI D'INGOMBRO

OVERALL DIMENSIONS



VC/T 500÷1120

Peso ventilatore in Kg (completo di motore) - Weight of ventilator (complete with motor)

Nota: Quota B indicativa - Note: B quote indicative

TIPO - TYPE VENTILATORE FAN	PESO WEIGHT kgf	PD ² GD ² kgf m ²			VENTILATORE FAN														
			V	Z	A	B	C	D	E	F	G	H	H ₁	H ₂	d	d ₁	d ₂	n°	∅
VC 500/N	65	1,2	28	60	48	665	715	335	795	347	41	450	335	450	145	182	215	8	8
VC 560/N	80	1,8	28	60	52	675	805	375	890	393	46	500	375	500	165	200	235	8	8
VC 630/N	114	3,1	38	80	58	705	910	425	1000	443	53	560	425	560	185	219	250	8	8
VC 710/N	148	5,9	42	110	64	825	1015	475	1122	497	58	550	475	630	205	241	275	8	8
VC 800/N	185	10,2	42	110	70	835	1140	530	1265	560	64	620	530	710	228	265	298	8	8
VC 900/N	300	17,7	48	110	77	850	1285	600	1428	631	71	695	600	800	255	292	325	8	10
VC 1000/N	380	24	48	110	86	955	1430	670	1590	707	81	770	670	900	285	332	365	8	10
VC 1120/N	460	43	55	110	95	975	1600	750	1770	791	91	860	750	1000	320	366	400	8	10

TIPO - TYPE VENTILATORE FAN	FLANGIA PREMENTE OUTLET FLANGE										BASAMENTO BASE																		
	a	b	a ₁	b ₁	a ₂	b ₂	n ₁ xp	n ₂ xp	n°	∅	I	J	K	L	M	N	O	O ₁	P	Q	R	S	T	U	V	W	X	Z	∅
VC 500/N	105	76	139	110	165	136	-	-	4	10	407	-	-	28	485	50	355	-	400	463	22,5	660	1060	120	-	-	-	-	14
VC 560/N	117	85	151	119	177	145	-	-	4	10	407	-	-	28	485	50	355	-	400	463	22,5	780	1180	120	-	-	-	-	14
VC 630/N	131	95	165	129	191	155	-	1x100	6	10	407	-	-	28	485	50	355	-	400	463	22,5	780	1180	120	-	-	-	-	14
VC 710/N	146	105	182	139	216	175	-	1x112	6	12	477	-	-	33	560	50	485	400	530	543	22,5	720	1250	160	191	721	205	20	17
VC 800/N	166	117	200	151	236	187	-	1x112	6	12	477	-	-	33	560	50	485	410	530	543	22,5	970	1500	160	203	733	520	20	17
VC 900/N	185	131	219	165	255	201	-	1x112	6	12	477	-	-	33	560	50	485	420	530	543	22,5	970	1500	160	219	749	540	20	17
VC 1000/N	207	148	241	182	277	218	1x112	1x112	8	12	551	-	-	39	650	60	762	450	826	629	32	974	1800	180	261	886	826	35	19
VC 1120/N	231	166	265	200	301	236	1x112	1x112	8	12	551	-	-	39	650	60	862	520	926	629	32	974	1900	180	279	904	926	35	19

PRESTAZIONI VENTILATORI A TRASMISSIONE

BELT DRIVEN FANS PERFORMANCES



VC 500/N

Il ventilatore è orientabile
The fan is revolvable

Peso ventilatore in kgf 65
Weight of ventilator in kgf 65

PD² = 1,2 kgf m²
GD² = 1,2 kgf m²

Massima velocità di rotazione
Maximum rotation speed

<100°C = 4000
100÷200°C = 3550
200÷300°C = 3150

Tolleranza sulla rumorosità + 3 dB(A)
Noise tolerance + 3 dB(A)

Tolleranza sulla potenza assorbita ± 3%
Absorbed power tolerance ± 3%

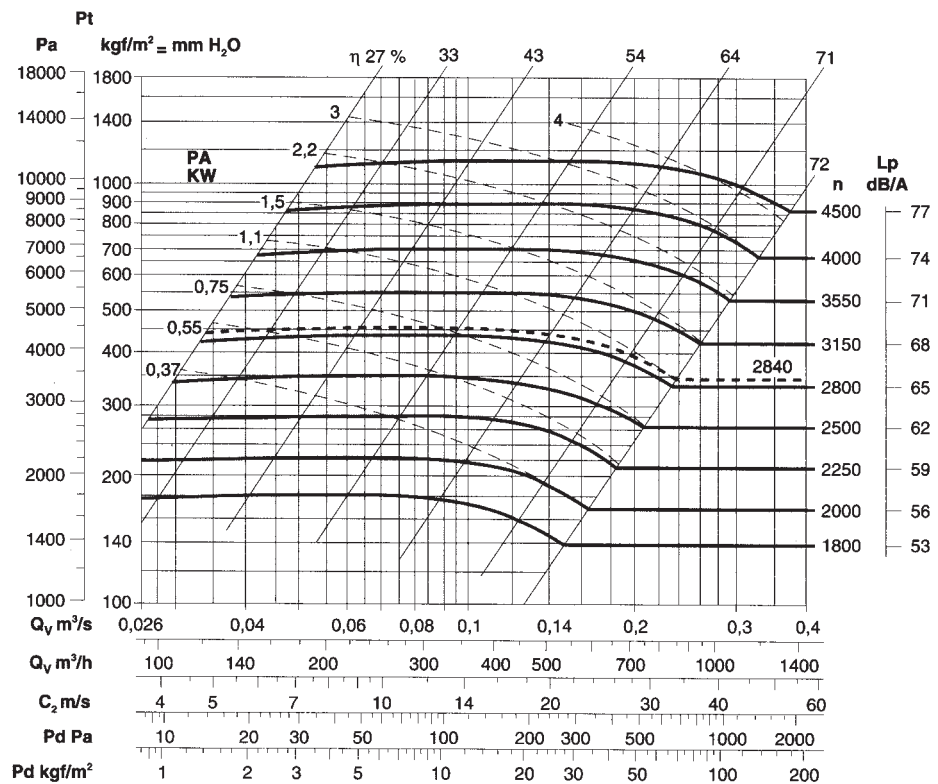

VC 560/N

Il ventilatore è orientabile
The fan is revolvable

Peso ventilatore in kgf 80
Weight of ventilator in kgf 80

PD² = 1,8 kgf m²
GD² = 1,8 kgf m²

Massima velocità di rotazione
Maximum rotation speed

<100°C = 3750
100÷200°C = 3350
200÷300°C = 3000

Tolleranza sulla rumorosità + 3 dB(A)
Noise tolerance + 3 dB(A)

Tolleranza sulla potenza assorbita ± 3%
Absorbed power tolerance ± 3%

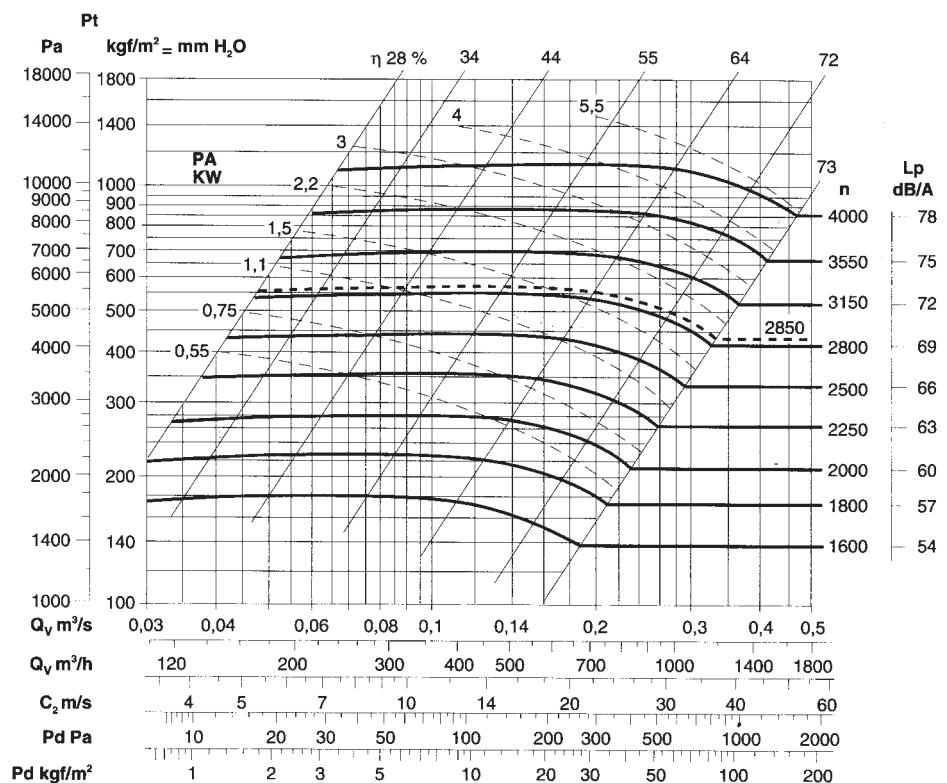



PRESTAZIONI VENTILATORI A TRASMISSIONE

BELT DRIVEN FANS PERFORMANCES

VC 630/N

Il ventilatore è orientabile
The fan is revolvable

Peso ventilatore in kgf 114
Weight of ventilator in kgf 114

PD² = 3 kgf m²
GD² = 3 kgf m²

Massima velocità di rotazione
Maximum rotation speed

<100°C = 3550
100÷200°C = 3150
200÷300°C = 2800

Tolleranza sulla rumorosità + 3 dB(A)
Noise tolerance + 3 dB(A)

Tolleranza sulla potenza assorbita ± 3%
Absorbed power tolerance ± 3%

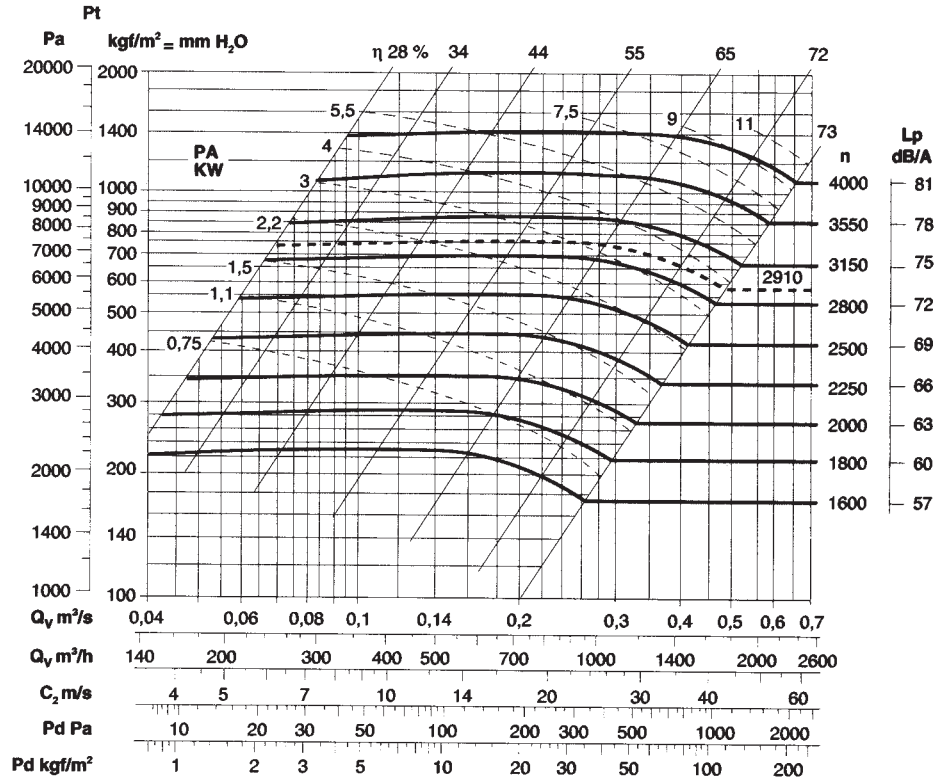

VC 710/N

Il ventilatore NON è orientabile
The fan is NOT revolvable

Peso ventilatore in kgf 148
Weight of ventilator in kgf 148

PD² = 5,9 kgf m²
GD² = 5,9 kgf m²

Massima velocità di rotazione
Maximum rotation speed

<100°C = 3350
100÷200°C = 3000
200÷300°C = 2650

Tolleranza sulla rumorosità + 3 dB(A)
Noise tolerance + 3 dB(A)

Tolleranza sulla potenza assorbita ± 3%
Absorbed power tolerance ± 3%

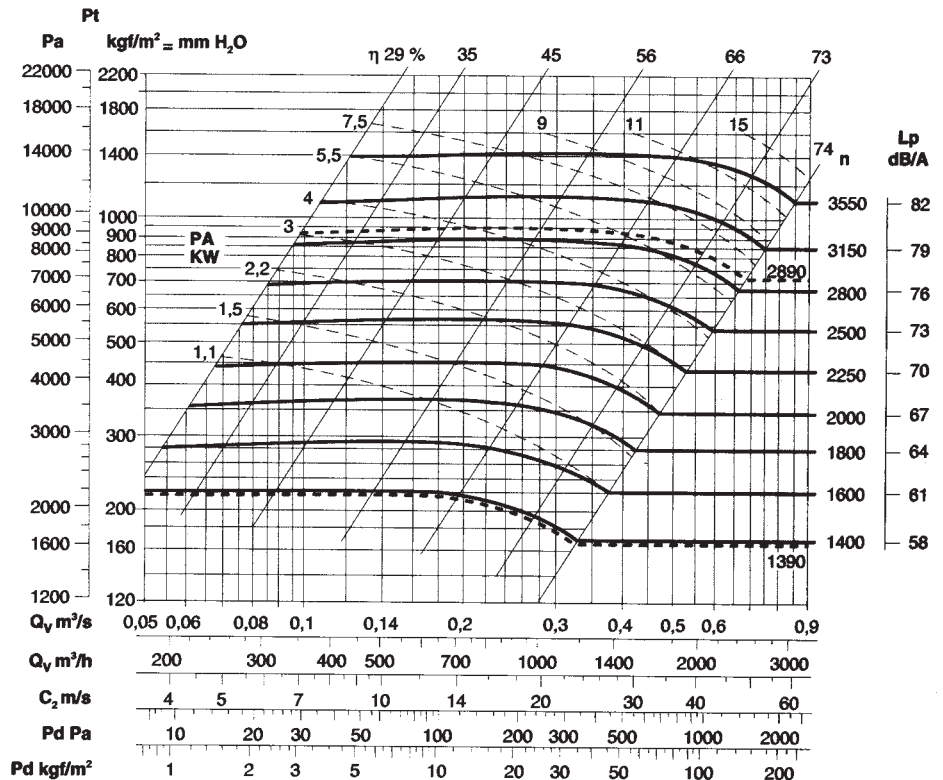

PRESTAZIONI VENTILATORI A TRASMISSIONE BELT DRIVEN FANS PERFORMANCES



VC 800/N

Il ventilatore NON è orientabile
The fan is NOT revolvable

Peso ventilatore in kgf 185
Weight of ventilator in kgf 185

PD² = 10,2 kgf m²
GD² = 10,2 kgf m²

Massima velocità di rotazione
Maximum rotation speed

<100°C = 3150
100÷200°C = 2800
200÷300°C = 2500

Tolleranza sulla rumorosità + 3 dB(A)
Noise tolerance + 3 dB(A)

Tolleranza sulla potenza assorbita ± 3%
Absorbed power tolerance ± 3%

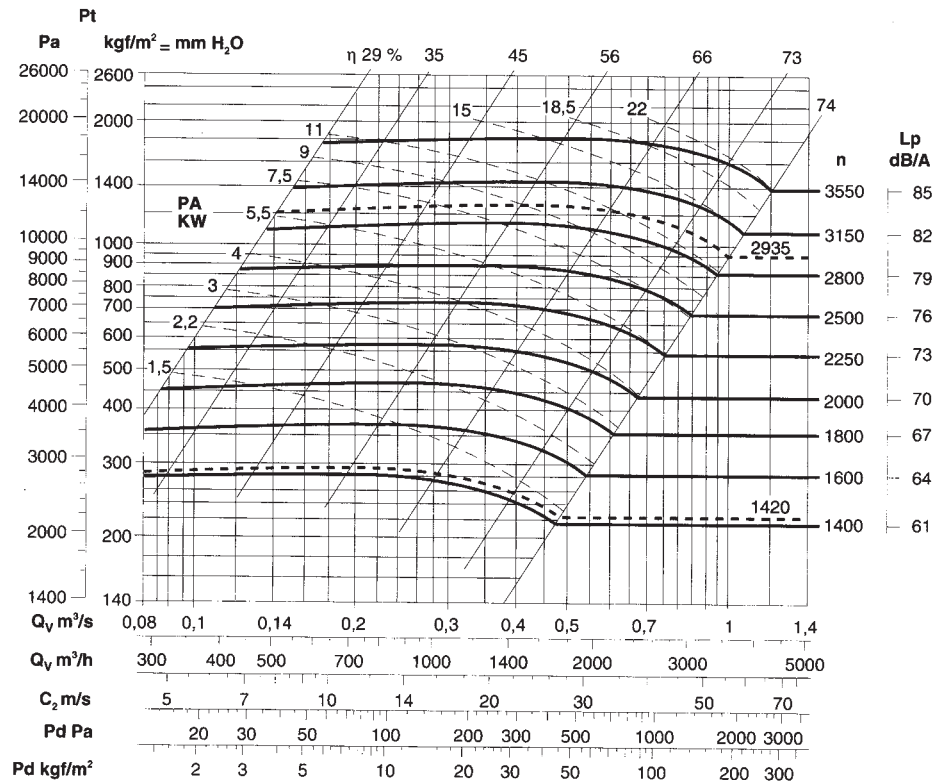

VC 900/N

Il ventilatore NON è orientabile
The fan is NOT revolvable

Peso ventilatore in kgf 300
Weight of ventilator in kgf 300

PD² = 17,7 kgf m²
GD² = 17,7 kgf m²

Massima velocità di rotazione
Maximum rotation speed

<100°C = 3000
100÷200°C = 2650
200÷300°C = 2350

Tolleranza sulla rumorosità + 3 dB(A)
Noise tolerance + 3 dB(A)

Tolleranza sulla potenza assorbita ± 3%
Absorbed power tolerance ± 3%

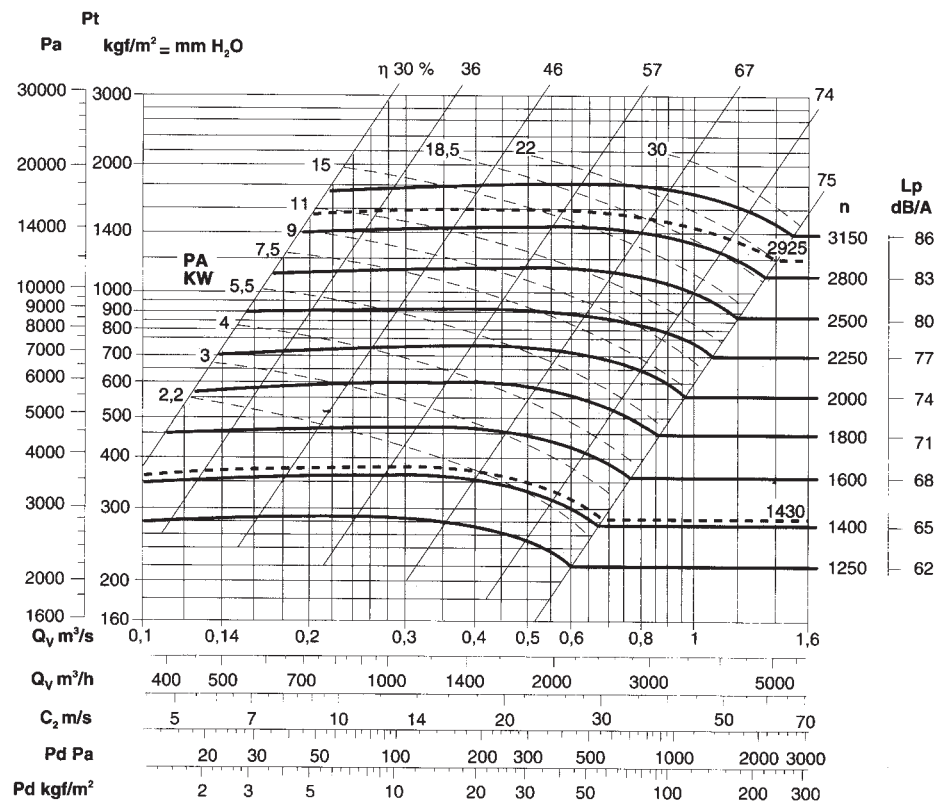



PRESTAZIONI VENTILATORI A TRASMISSIONE

BELT DRIVEN FANS PERFORMANCES

VC 1000/N

Il ventilatore NON è orientabile
The fan is NOT revolvable

Peso ventilatore in kgf 380
Weight of ventilator in kgf 380

PD² = 24 kgf m²
GD² = 24 kgf m²

Massima velocità di rotazione
Maximum rotation speed

<100°C = 2800
100÷200°C = 2500
200÷300°C = 2240

Tolleranza sulla rumorosità + 3 dB(A)
Noise tolerance + 3 dB(A)

Tolleranza sulla potenza assorbita ± 3%
Absorbed power tolerance ± 3%

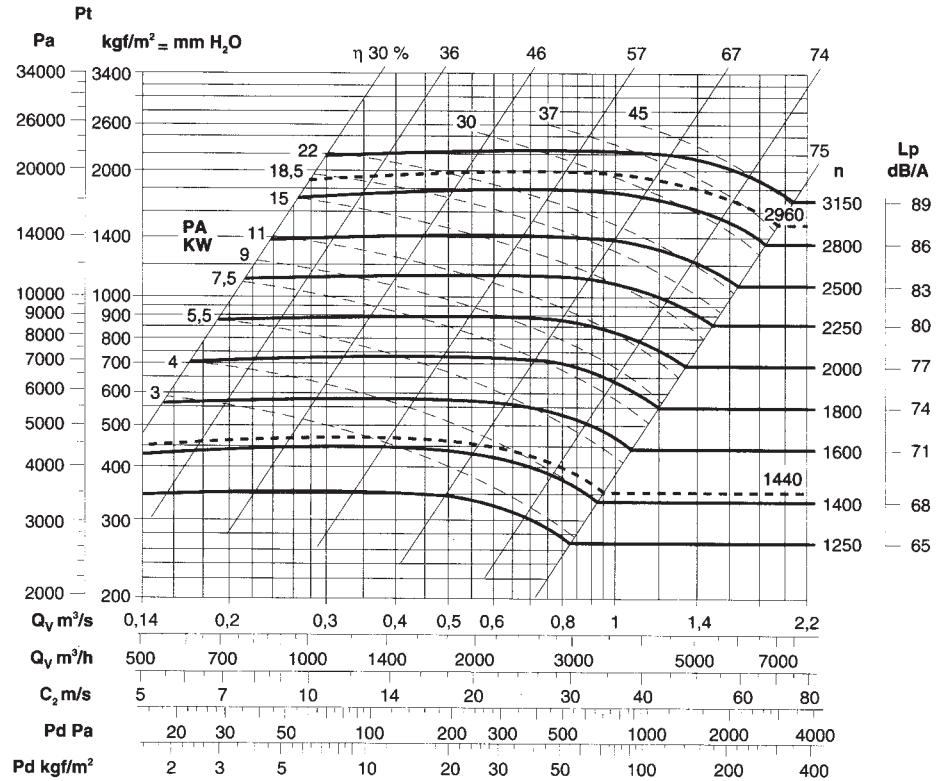

VC 1120/N

Il ventilatore NON è orientabile
The fan is NOT revolvable

Peso ventilatore in kgf 460
Weight of ventilator in kgf 460

PD² = 43 kgf m²
GD² = 43 kgf m²

Massima velocità di rotazione
Maximum rotation speed

<100°C = 2650
100÷200°C = 2350
200÷300°C = 2100

Tolleranza sulla rumorosità + 3 dB(A)
Noise tolerance + 3 dB(A)

Tolleranza sulla potenza assorbita ± 3%
Absorbed power tolerance ± 3%

